

buildingSMART OG STORTINGSMELDINGEN

GARDERMOEN – 25.04.2013 – STEEN SUNESEN

buildingSMART NORGE TENKER OGSÅ PÅ ST. MELD 28:

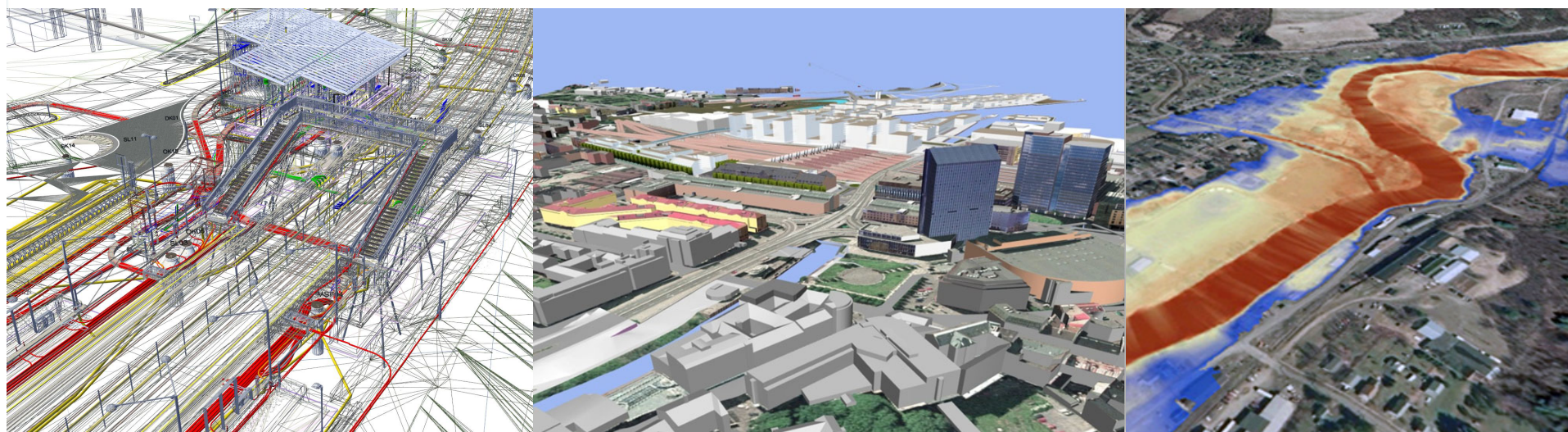

buildingSMART OG STORTINGSMELDINGEN

GARDERMOEN – 25.04.2013 – STEEN SUNESEN

FORUTSETTER SØMLØS INFORMASJONSUTVEKSLING

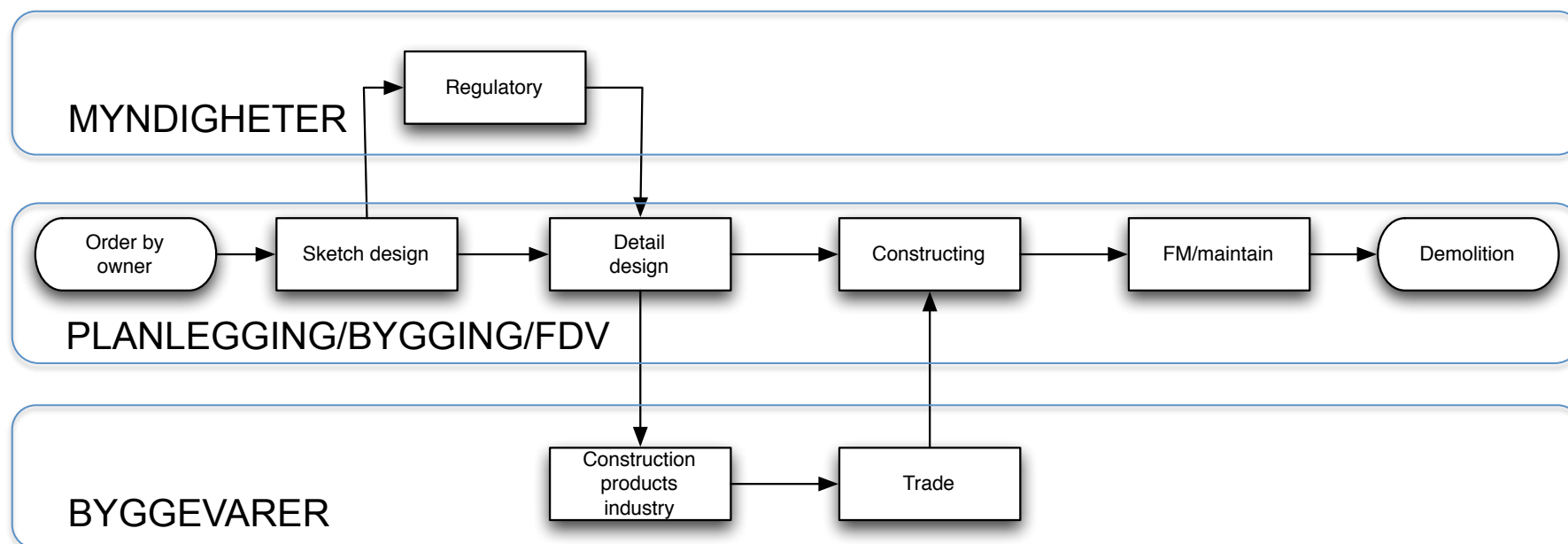

Current understanding of user requirements for interoperability in Civil/Infra (Contractor point of view)



buildingSMART OG STORTINGSMELDINGEN

GARDERMOEN – 25.04.2013 – STEEN SUNESEN

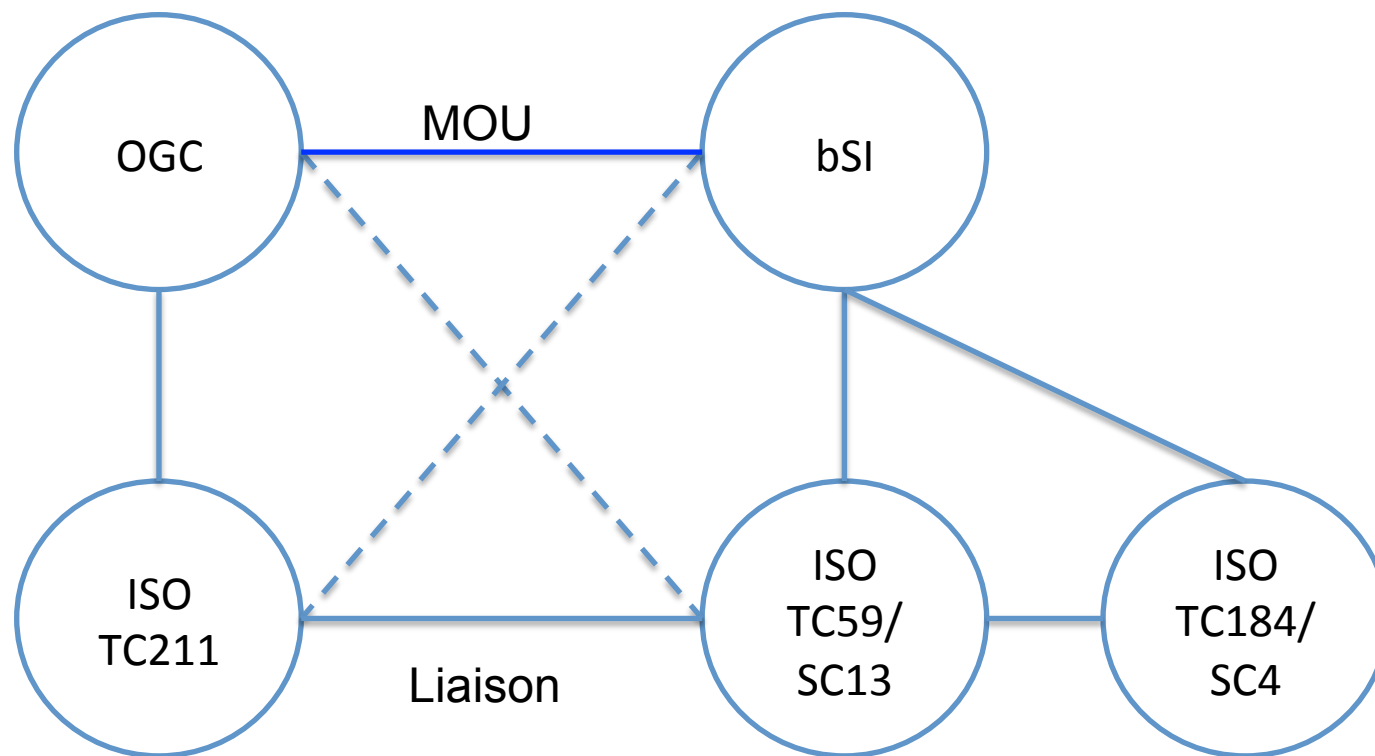

buildingSMART OG STORTINGSMELDINGEN

GARDERMOEN – 25.04.2013 – STEEN SUNESEN

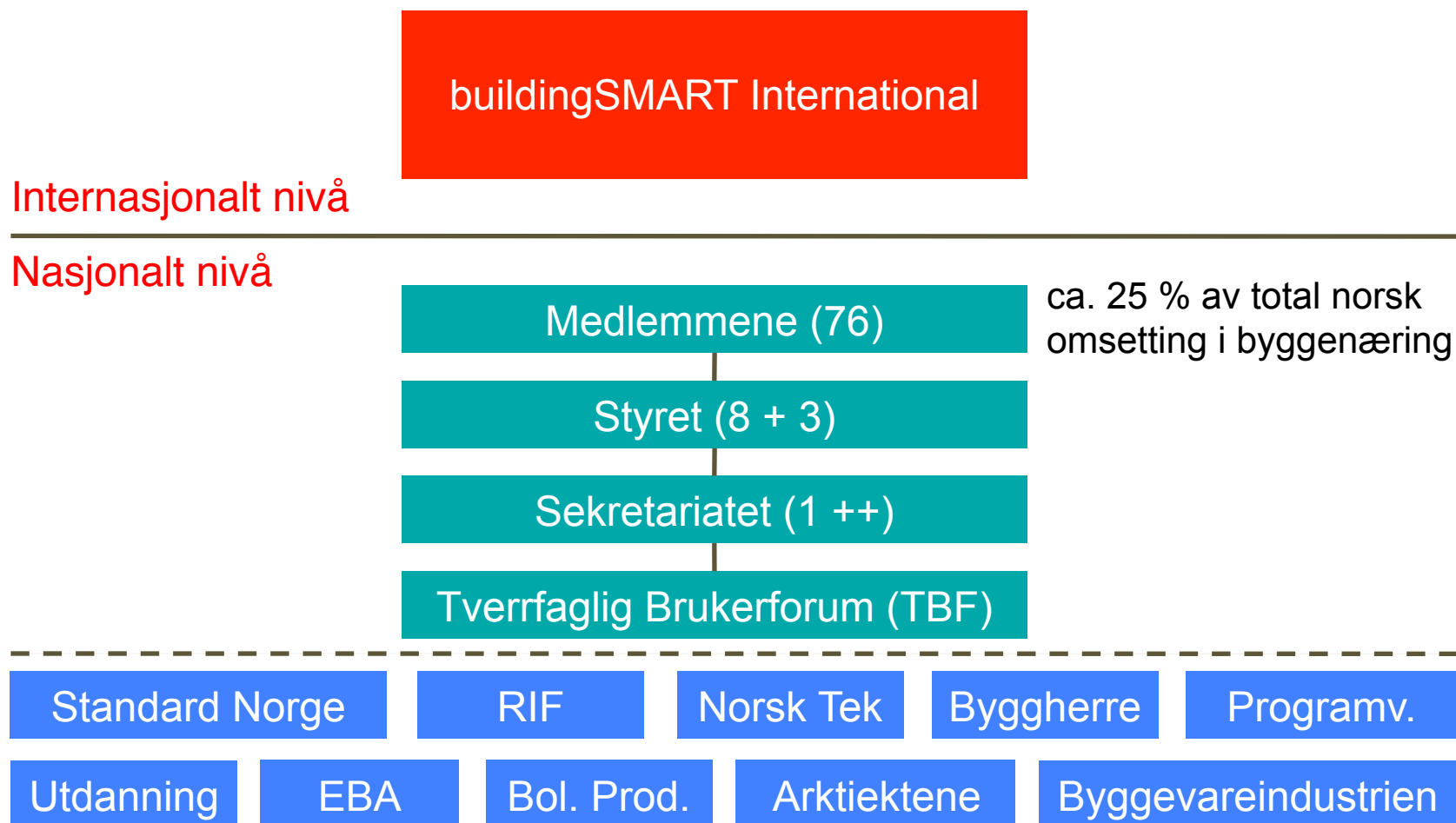

buildingSMART OG STORTINGSMELDINGEN

GARDERMOEN – 25.04.2013 – STEEN SUNESEN



TVERRSEKTORIELL SAMHANDLING

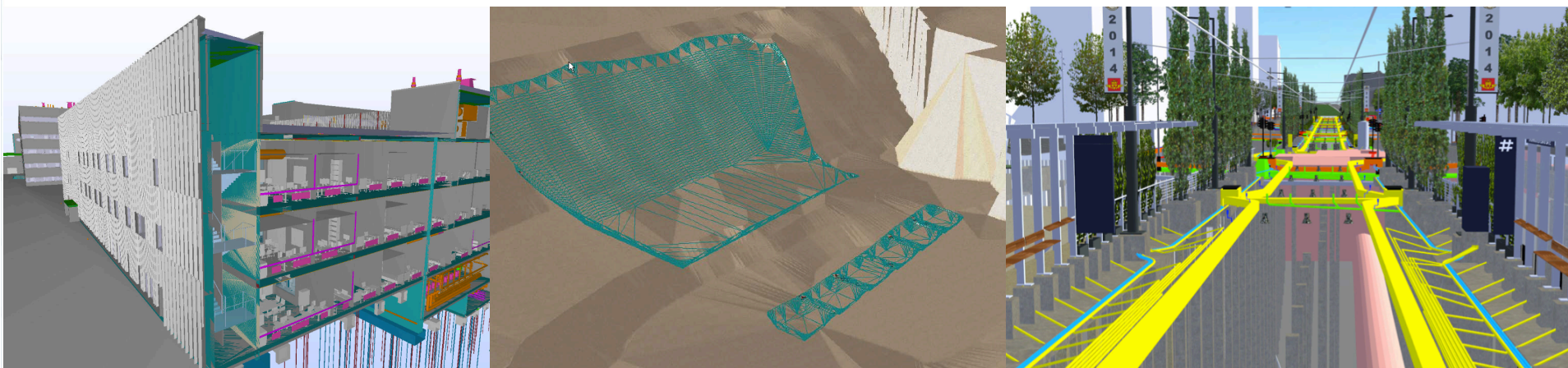

*TVERRSEKTORIELT SAMHANDLINGSPROSJEKT
FOR BYGG, SAMFERDSEL, ANNEN SAMFUNNSVIKTIG
INFRASTRUKTUR OG GEODATA*

buildingSMART OG STORTINGSMELDINGEN

GARDERMOEN – 25.04.2013 – STEEN SUNESEN

SEKTORENE SOM OMFATTES AV PROSJEKTET

- Kommuner og reguleringsplan
- Bygg
- Vei
- Jernbane
- Kart
- Matrikkel
- Ledning
- ITS

		Mottaker							
		1.	2.	3.	4.	5.	6.	7.	8.
Avsender	1.	1.1	2.1	3.1	4.1	5.1	6.1	7.1	8.1
	2.	1.2	2.2	3.2	4.2	5.2	6.2	7.2	8.2
	3.	1.3	2.3	3.3	4.3	5.3	6.3	7.3	8.3
	4.	1.4	2.4	3.4	4.4	5.4	6.4	7.4	8.4
	5.	1.5	2.5	3.5	4.5	5.5	6.5	7.5	8.5
	6.	1.6	2.6	3.6	4.6	5.6	6.6	7.6	8.6
	7.	1.7	2.7	3.7	4.7	5.7	6.7	7.7	8.7
	8.	1.8	2.8	3.8	4.8	5.8	6.8	7.8	8.8

buildingSMART OG STORTINGSMELDINGEN

GARDERMOEN – 25.04.2013 – STEEN SUNESEN

BYGGNETT - EN BLANT FLERE PORTALER ELLER PORTALEN?

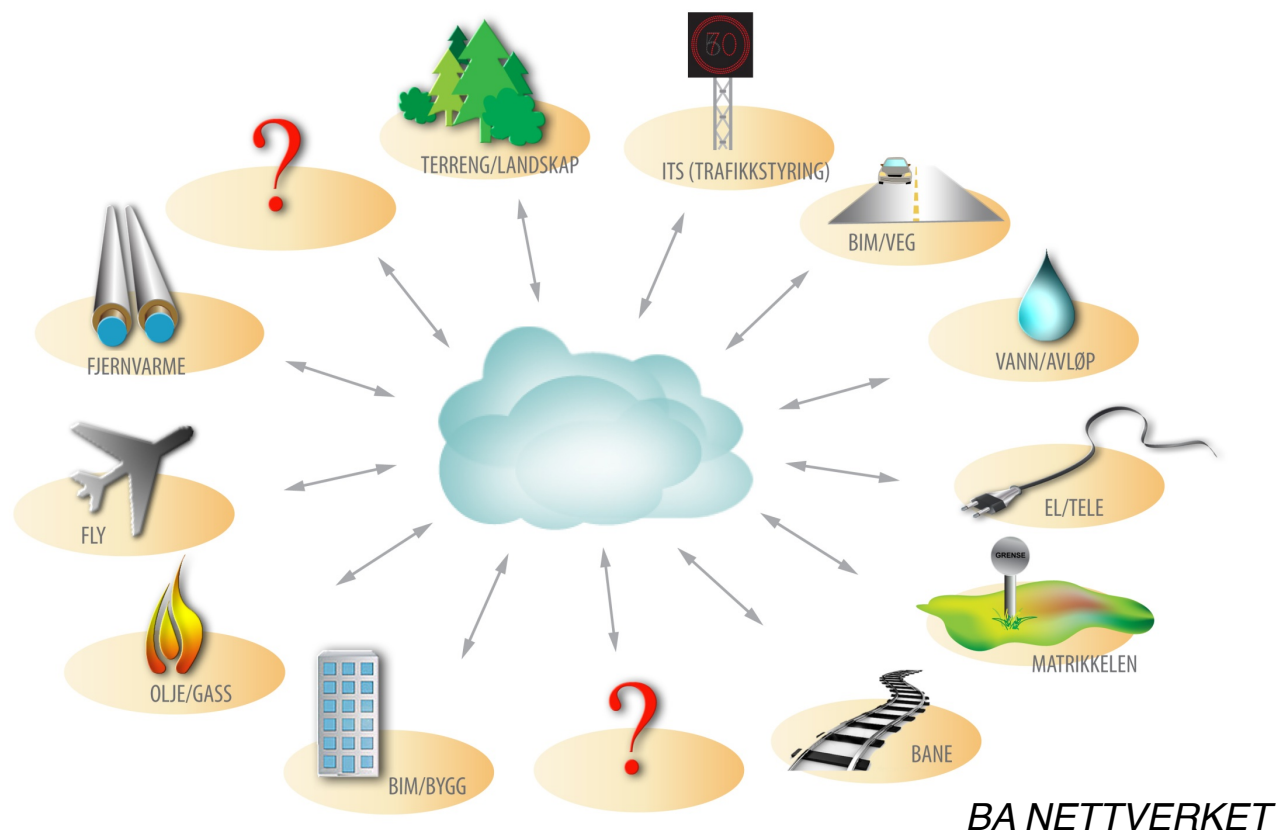

buildingSMART OG STORTINGSMELDINGEN

GARDERMOEN – 25.04.2013 – STEEN SUNESEN

FUNDAMENTET FOR TVERRRSEKTORIELLE PORTALER

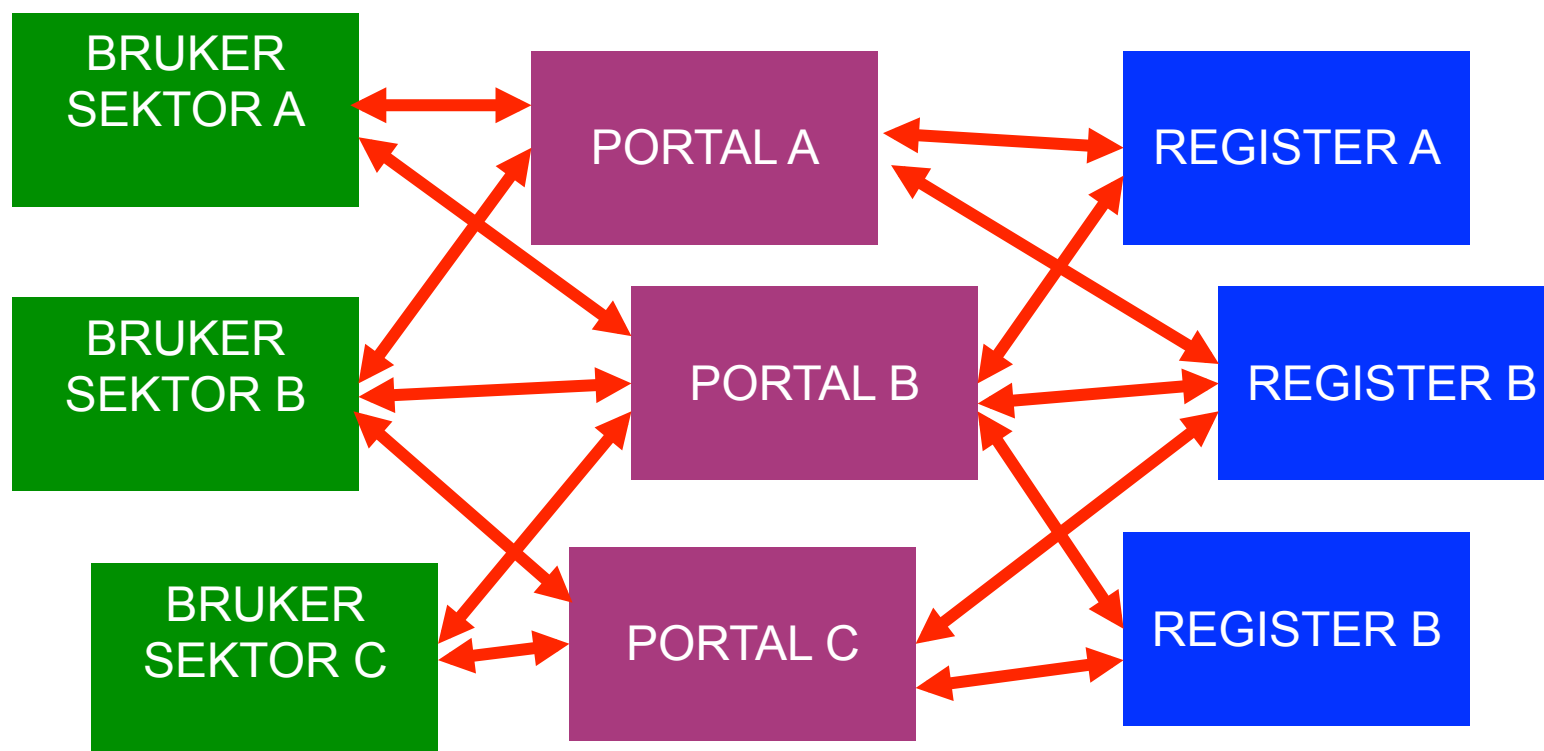

buildingSMART NORGE

buildingSMART OG STORTINGS
GARDERMOEN – 25.04.2013 – STEEN SUNES

**TVERRSEKTORIET
SAMHANDLINGSPROSJEKT**
Forprosjektrapport sendes ut i mai



SMART®

NORGE